

# Bravura KNOBS & LEVERS

## Specifications: ANSI Rated Grade 2

<b>Door Prep</b>	Cross bore: 2-1/8" Edge bore: 1" Latch Face: 1" x 2-1/4"	<b>Latches</b>	2-3/8" Standard and 2-3/4" Optional Faceplate: 1" x 2-1/4" round corner Bolt: 1/2" Solid Brass throw Drive0in or UL Available
<b>Backset</b>	2-3/8" Standard and 2-3/4" Optional	<b>Strikes</b>	Full lip round corner (9103) & square
<b>Door Thickness</b>	1-3/8" ~ 2", 2-1/4" & 2-1/2" Extension Kits Available		

## CRYSTAL



**925-0**  
Shown in US26  
Also available in: PVD, US4, US10B,  
US15, US19  
Passage/Privacy  
Dummy

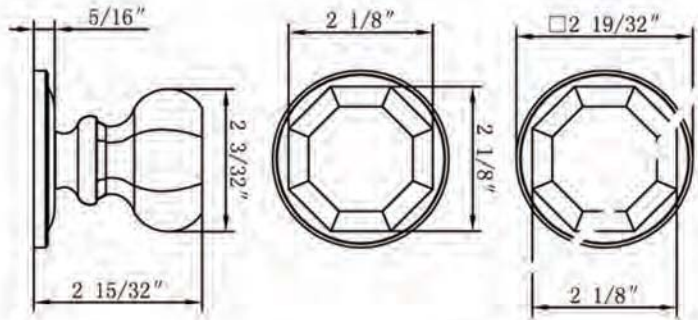

**926-0**  
Shown in US26  
Also available in: PVD, US4, US10B,  
US15, US19  
Passage/Privacy  
Dummy

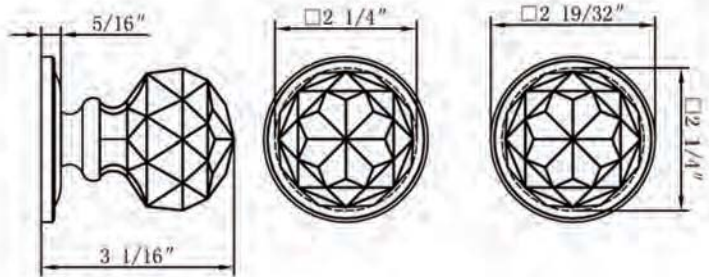

**925-6**  
Shown in US15  
Also available in: US4, US10B, US19,  
US26  
Passage/Privacy  
Dummy

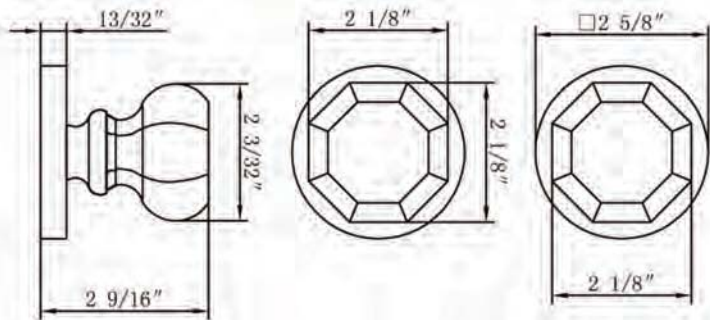

**926-6**  
Shown in US15  
Also available in: US4, US10B,  
US19, US26  
Passage/Privacy  
Dummy

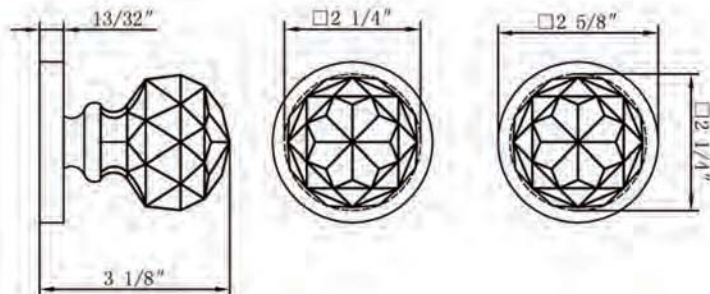

### HOW TO ORDER PASSAGE & PRIVACY

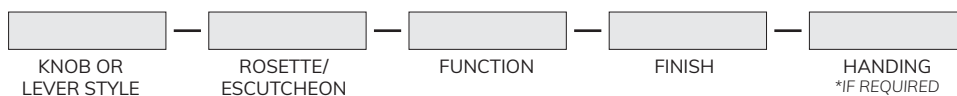

### CRYSTAL



**925-7**  
Shown in US10B  
Also available in: US4, US15, US19, US26  
Passage/Privacy Dummy

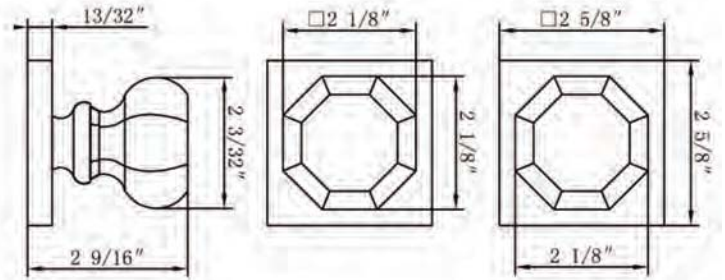

**926-7**  
Shown in US10B  
Also available in: US4, US15, US19, US26  
Passage/Privacy Dummy

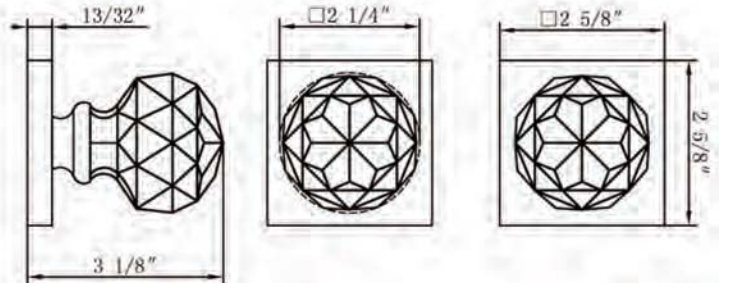

**925-1**  
Shown in US10B  
Also available in: PVD, US4, US15, US19, US26  
Passage/Privacy Dummy

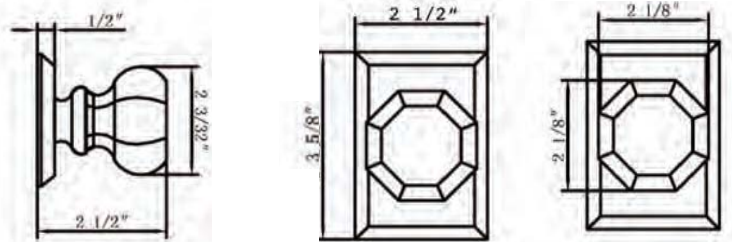

**926-1**  
Shown in US10B  
Also available in: PVD, US4, US15, US19, US26  
Passage/Privacy Dummy

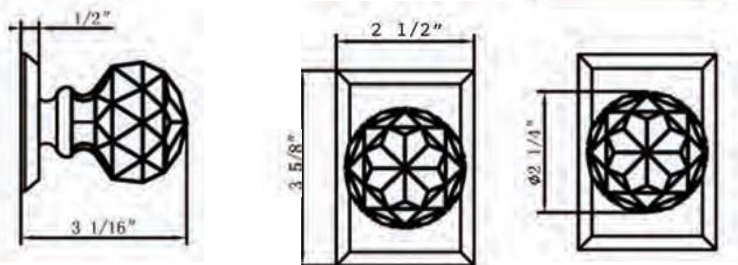

**925-2**  
Shown in US10B  
Also available in: US15  
Passage/Privacy Dummy

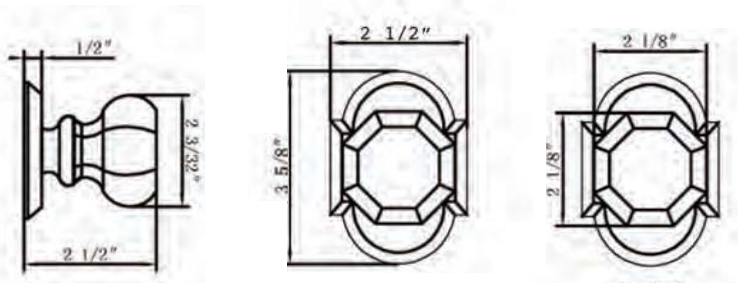

### HOW TO ORDER PASSAGE & PRIVACY

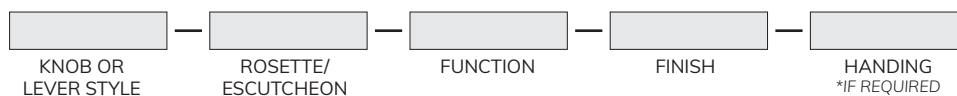

# Bravura KNOBS & LEVERS



**926-2**  
 Shown in US10B  
 Also available in: US15  
 Passage/Privacy  
 Dummy

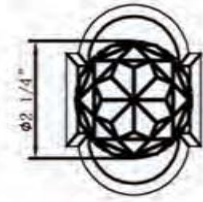
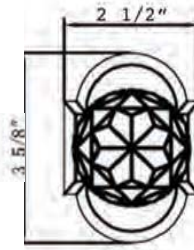
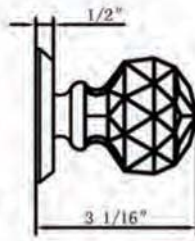

**925G-1**  
 Shown in US10B  
 Also available in: PVD, US4,  
 US15, US19  
 Passage/Privacy  
 Dummy

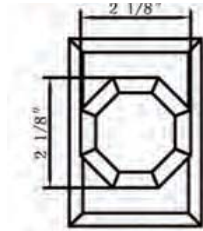
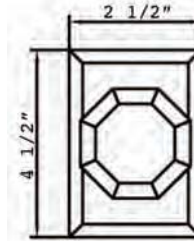
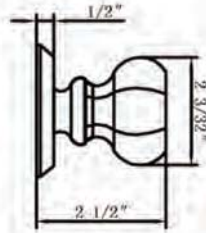

**926G-1**  
 Shown in US10B  
 Also available in: PVD, US4, US15,  
 US19, US26  
 Passage/Privacy  
 Dummy

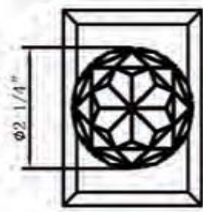
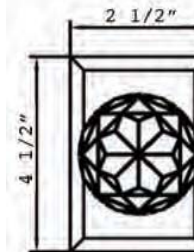
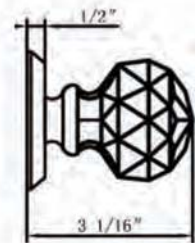

**925G-2**  
 Shown in US10B  
 Also available in: US4, US15, US19  
 Passage/Privacy  
 Dummy

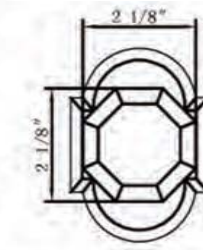
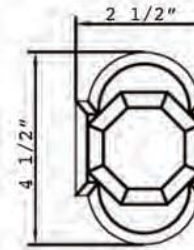
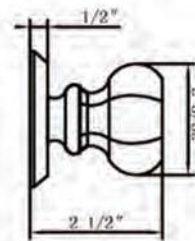

**926G-2**  
 Shown in US10B  
 Also available in: US4, US15, US19  
 Passage/Privacy  
 Dummy

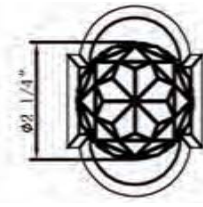
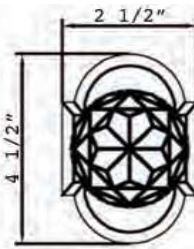
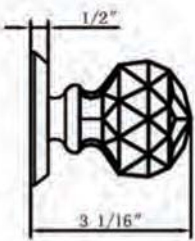

## HOW TO ORDER PASSAGE & PRIVACY

