

# Bravura KNOBS & LEVERS

## Specifications: ANSI Rated Grade 2

<b>Door Prep</b>	Cross bore: 2-1/8" Edge bore: 1" Latch Face: 1" x 2-1/4"	<b>Latches</b>	2-3/8" Standard and 2-3/4" Optional Faceplate: 1" x 2-1/4" round corner Bolt: 1/2" Solid Brass throw Drive0in or UL Available
<b>Backset</b>	2-3/8" Standard and 2-3/4" Optional	<b>Strikes</b>	Full lip round corner (9103) & square
<b>Door Thickness</b>	1-3/8" ~ 2", 2-1/4" & 2-1/2" Extension Kits Available		

## TRADITIONAL



**903-0**  
Shown in Bright Chrome US15  
Passage/Privacy  
Dummy  
(Specify Door Handling)

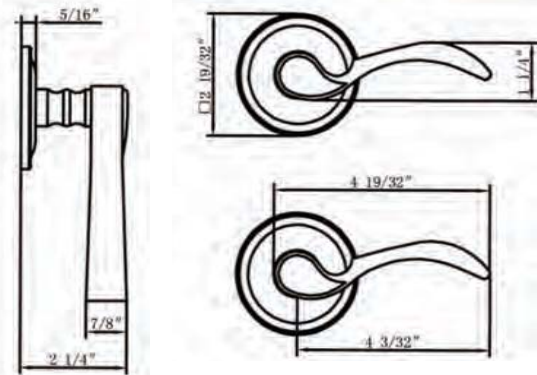

**904-0**  
Shown in US15  
Also available in: US10B, US19  
Passage/Privacy  
Dummy

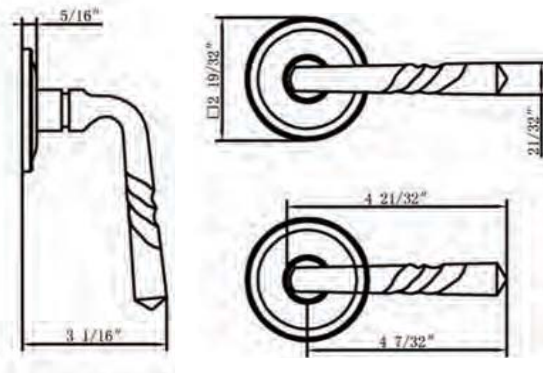

**904S-0**  
Shown in US15  
Also available in: US4, US10B, US19, US26  
Passage/Privacy  
Dummy

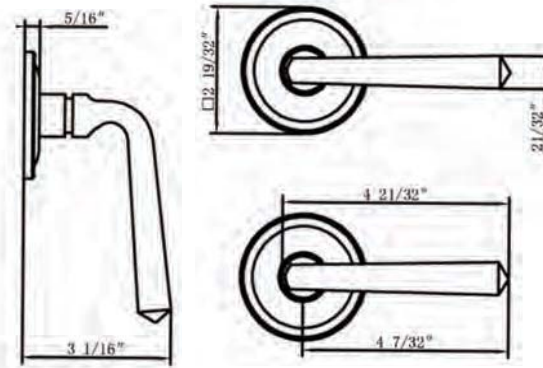

### HOW TO ORDER PASSAGE & PRIVACY

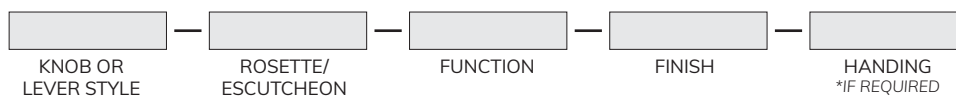

### TRADITIONAL



**931-0**

Shown in US10B  
Also available in: US4, US15, US19, US26

Passage/Privacy  
Dummy

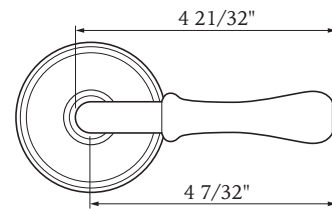
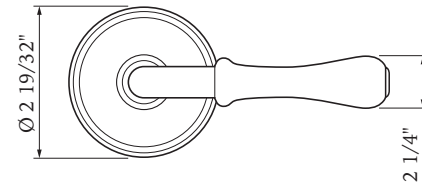
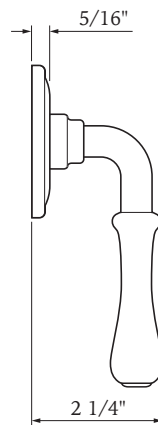

**903-0**

Shown in US10B  
Also available in: US15, US26

Passage/Privacy

Dummy  
(Specify Door Handling)

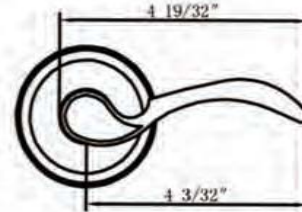
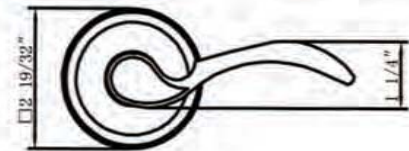
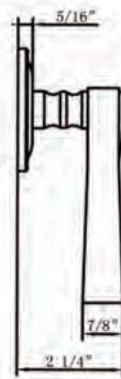

**905-0**

Shown in US15  
Also available in: VD, US10B, US26

Passage/Privacy  
Dummy

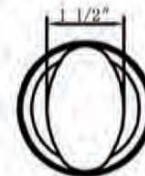
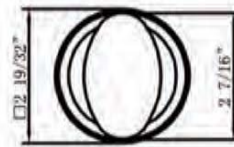
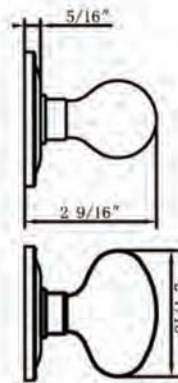

**906-0**

Shown in US10B  
Also available in: PVD, US15, US26

Passage/Privacy  
Dummy

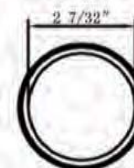
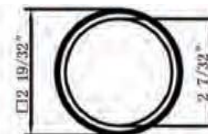
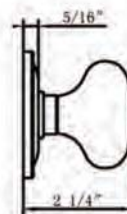

### HOW TO ORDER PASSAGE & PRIVACY

