

## Specifications: ANSI Rated Grade 2

<b>Door Prep</b>	Cross bore: 2-1/8" Edge bore: 1" Latch Face: 1" x 2-1/4"	<b>Latches</b>	2-3/8" Standard and 2-3/4" Optional Faceplate: 1" x 2-1/4" round corner Bolt: 1/2" Solid Brass throw Drive0in or UL Available
<b>Backset</b>	2-3/8" Standard and 2-3/4" Optional	<b>Strikes</b>	Full lip round corner (9103) & square
<b>Door Thickness</b>	1-3/8" ~ 2", 2-1/4" & 2-1/2" Extension Kits Available	<b>Rosette Size</b>	2-5/8" diameter

## MODERNE



**945-0**  
Shown in US26  
Passage/Privacy  
Dummy  
(Specify Door Handling)

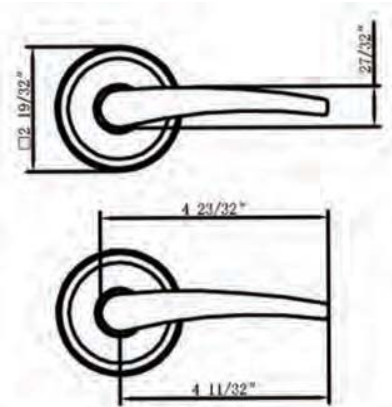
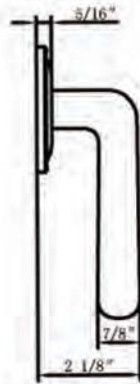

**935-0**  
Shown in US15  
Also available in: US10B, US26  
Passage/Privacy  
Dummy  
(Specify Door Handling)

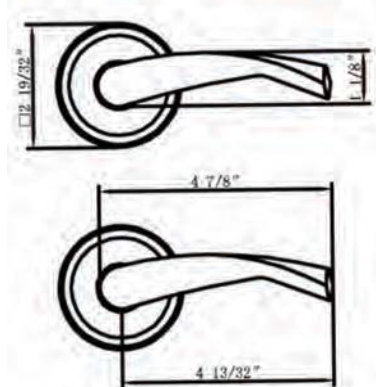
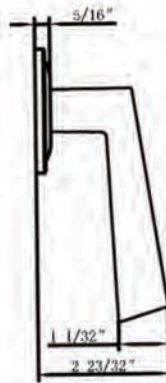

**937-0**  
Shown in US15  
Also available in: US10B, US26  
Passage/Privacy  
Dummy  
(Specify Door Handling)

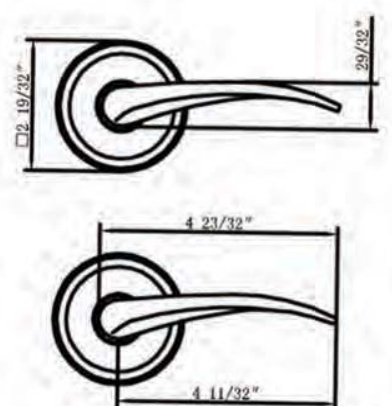

### HOW TO ORDER PASSAGE & PRIVACY

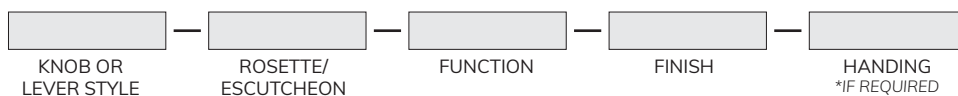

### MODERNE



**945-0**  
 Shown in US15  
 Also available in: US4, US10B, US26  
 Passage/Privacy  
 Dummy  
 (Specify Door Handling)

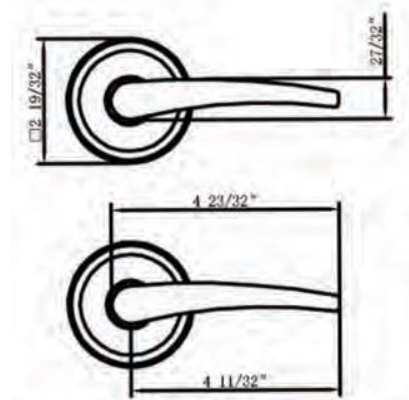
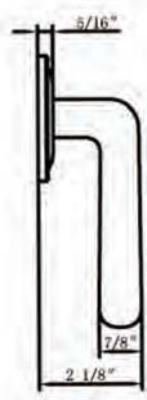

**944-0**  
 Shown in US15  
 Also available in: US10B, US26  
 Passage/Privacy  
 Dummy

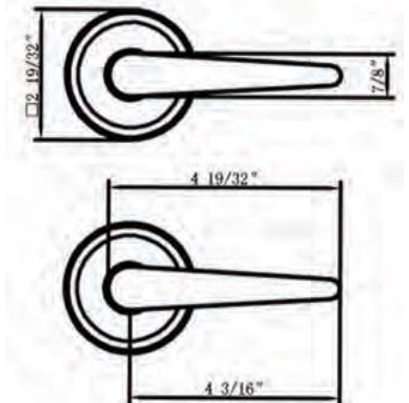
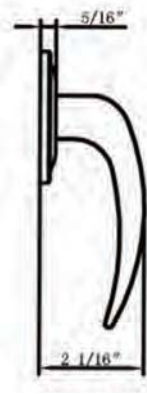

**939-0**  
 Shown in US15  
 Also available in: US4, US10B, US19, US26  
 Passage/Privacy  
 Dummy

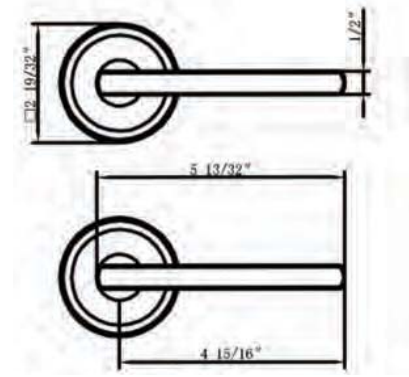
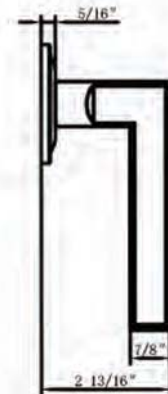

**942-0**  
 Shown in US15  
 Also available in: US10B, US26  
 Passage/Privacy  
 Dummy

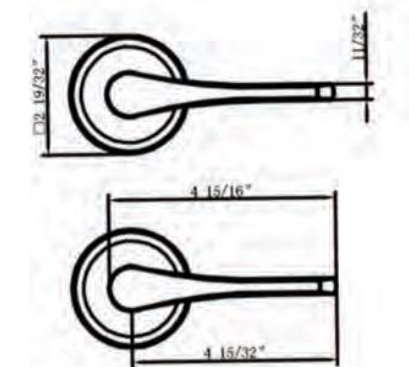
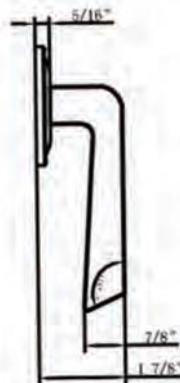

#### HOW TO ORDER PASSAGE & PRIVACY

